

CE

GANN HYDROMETTE UNI 1 + UNI 2

Operating instructions

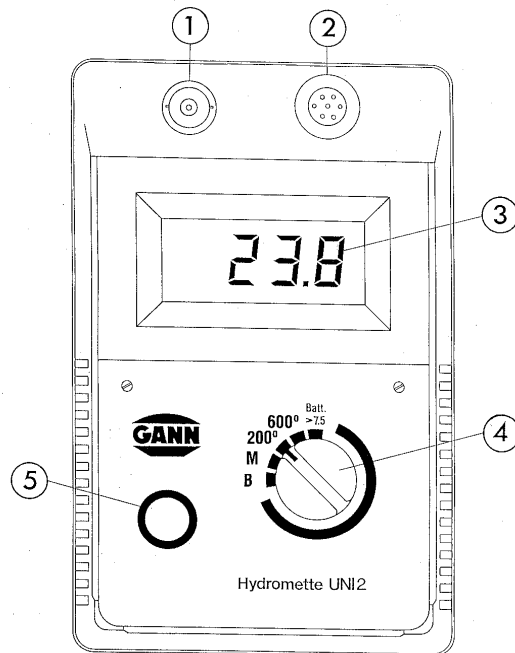

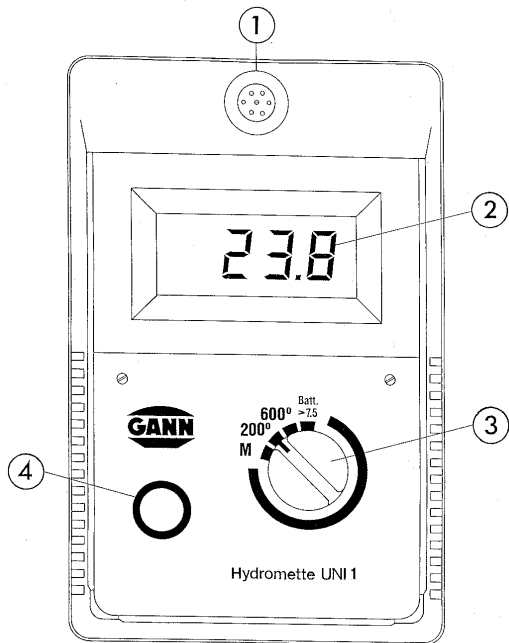

All copyrights reserved

Reproduction of this manual, also in part, by print, copying or any other procedure is not permitted unless approved in writing by GANN Mess- u. Regeltechnik GmbH.

This manual has been most carefully composed. The manufacturer and/or supplier assumes no liability, however, for possible misprints or errors.

**Copyright by GANN Mess- u. Regeltechnik GmbH.
Stuttgart, Federal Republic of Germany**

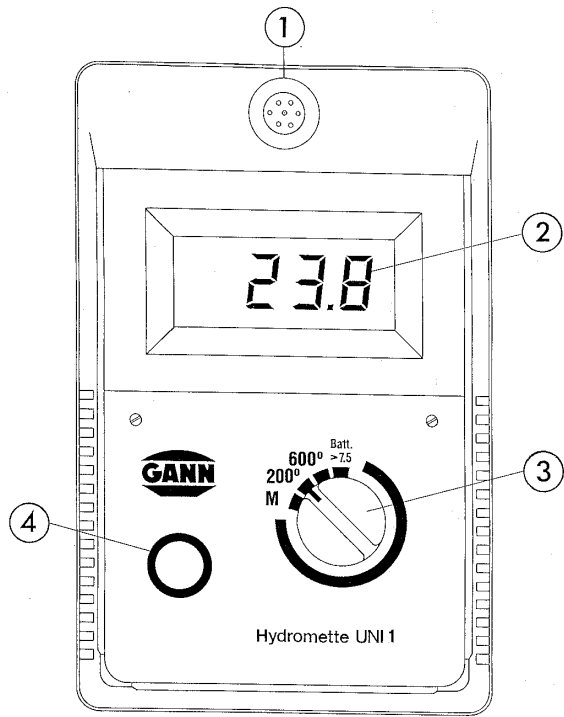

Technical Specifications - Hydromette UNI 1

(1) MS Connection Socket

for connection of temperature probes PT 100,
all active electrodes and infrared sensor IR 40

(2) LCD Readout

for all measurements

(3) Selector Switch

»position M«

for measurements using the following active electrodes:

MH 34 for moisture measurements on coniferous wood in the range between 40 and 200 % m.c.

MB 35 for non-destructive moisture measurements of concrete surfaces

B 50 for non-destructive moisture measurements of set inorganic construction materials (concrete, cement flooring, etc.)

RF-T 28 for air humidity measurements,

RF-T 31 for air humidity measurements,

RF-T 32 for air humidity measurements,

IR 40 for surface temperature measurements with infrared sensor,

»position 200«

for temperature measurements up to 200 °C with electrodes RF-T 28, RF-T 31, RF-T 32 and temperature probes PT 100,

»position 600«

for temperature measurements up to 600 °C using temperature probes PT 100,

»position Batt«

for battery check.

(4) Measuring Key

ON/OFF

Battery Check

Set selector switch (3) to position »Batt« and press measuring key (4). The reading displayed should be higher than 7.5 digits. If it is 7.5 digits or lower, the battery is exhausted and should be replaced or recharged if a rechargeable battery is being used. The cover of the battery compartment can be lifted by means of a coin inserted into the slot. It is recommendable to replace or recharge the battery once the reading of the battery check is below 8 digits.

Power Source

The meter is fitted, as standard, with a 9 V dry battery IEC 6 F 22 or IEC 6 LF 22. It is recommended to use alkali-mangan batteries.

A rechargeable nickel-cadmium battery can be fitted (optional accessory). It can be recharged from any A.C. lighting supply socket by means of the charging unit supplied with this special battery.

Calibration

The meter is fitted with an electronic setting device, making manual calibration or adjustment unnecessary.

Measuring ranges

| | | |
|-------------------------------------------|-----------------------------------------------|----------------------------------------------------------------------------------------------|
| Wood Moisture, position »M«: | 40 - 200 % m.c. | on coniferous wood using active electrode MH 34 |
| Structural Moisture, position »M«: | 0 - 199 digits | non-destructive measurement with active electrode B 50/B60 |
| | 0,3 - 8,5 % | of dry weight with active electrode B 50 and conversion table |
| | 1 - 8 % | of dry weight with active electrode MB 35 on non-destructive surface measurement of concrete |
| Air Humidity, position »M«: | 7 - 98 % R.H. | with live electrodes RF-T 28, RF-T 31, RF-T 32 and RF-T 36 |
| Temperature 1, position »200«: | -200 - +200 °C with temperature probes PT 100 | |
| Temperature 2, position »600«: | -200 - +600 °C with temperature probes PT 100 | |
| Temperature 3, position »M«: | -20,0 - +200 °C with infrared sensor IR 40. | |

If the measured value exceeds the measuring capacity, the figure »1« appears on the left side of the display screen (2).

Dimensions

Plastic casing: Length 140 mm x Width 90 mm x Height 42/50 mm.
Weight: about 220 g without accessory.

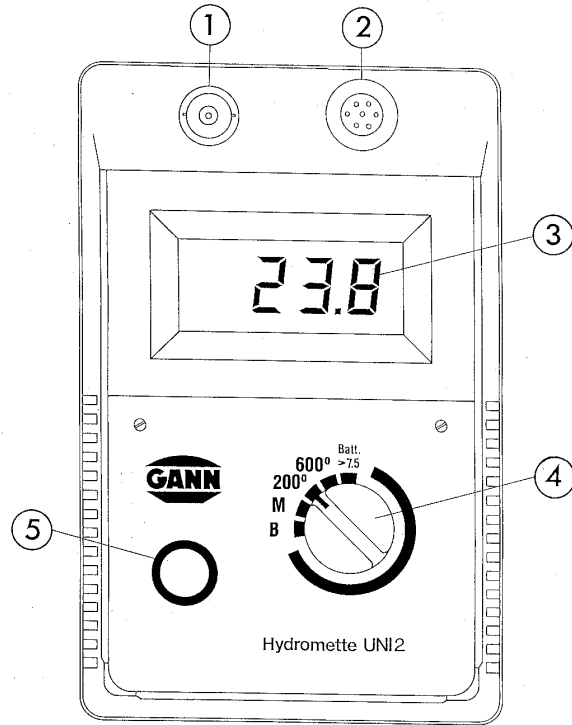

Technical Specifications - Hydromette UNI 2

- | | |
|----------------------------------|------------------------------------------------------------------------------------------------------------------------------------------------------------------------------------------------------------------------------------------------------------------------------------------------------------------------------------------------------------------------------------------------------------------------------------------------------------------------------------------------------------------------------------------------------------------------------------------------------------------------------------------------------------------------------------------------|
| (1) BNC Connection Socket | for connection of electrodes designed for testing set building materials according to the resistance method |
| (2) MS Connection Socket | for connection of temperature probes PT 100, all active electrodes and infrared sensor IR 40 |
| (3) LCD Readout | for all measurements |
| (4) Selector Switch | <p>»<i>position B</i>«</p> <p>for measurement of set building materials according to the resistance measuring method</p> <p>»<i>position M</i>«</p> <p>for measurements using the following active electrodes:</p> <p>MH 34 for moisture measurements on coniferous wood in the range between 40 and 200 % m.c.</p> <p>MB 35 for non-destructive moisture measurements of concrete surfaces</p> <p>B 50/B 60 for non-destructive moisture measurements of set inorganic construction materials (concrete, cement flooring, etc.)</p> <p>»<i>position M</i>«</p> <p>RF-T 28 for air humidity measurements,</p> <p>RF-T 31 for air humidity measurements,</p> |

»position M«

RF-T 32 for air humidity measurements,

RF-T 36 for air humidity measurements,

IR 40 for surface temperature measurements with infrared sensor,

»position 200«

for temperature measurements up to 200 °C with electrodes RF-T 28, RF-T 31, RF-T 32, RF-T 36 and temperature probes PT 100,

»position 600«

for temperature measurements up to 600 °C using probes PT 100,

»position Batt«

for battery check.

(5) Measuring Key

ON/OFF

Battery Check

Set selector switch (4) to position »Batt« and press measuring key (5). The reading displayed should be higher than 7.5 digits. If it is 7.5 digits or lower, the battery is exhausted and should be replaced or recharged if a rechargeable battery is being used. The cover of the battery compartment can be lifted by means of a coin inserted into the slot.

It is recommendable to replace or recharge the battery once the reading of the battery check is below 8 digits.

Power Source

The meter is fitted, as standard, with a 9 V dry battery IEC 6 F 22 or IEC 6 LF 22. It is recommended to use alkali-mangan batteries. A rechargeable nickel-cadmium battery can be fitted (optional accessory). It can be recharged from any A.C. lighting supply socket by means of the charging unit supplied with this special battery.

Calibration

The meter is fitted with an electronic setting device, making manual calibration or adjustment unnecessary.

Measuring ranges

| | | |
|-------------------------------------------|----------------|---------------------------------------------------------------------------------------------|
| Structural Moisture, position »B«: | 0 - 80 digits | with graphs for converting readings into percent of moisture for various building materials |
| Structural Moisture, position »M«: | 0 - 199 digits | non-destructive measurement with active electrode B 50/B60 |
| | 0,3 - 8,5 % | of dry weight with live electrode B 50 and conversion table |
| | 1 - 8 % | of dry weight with live electrode MB 35 on non-destructive surface measurement of concrete |
| Wood Moisture, position »M«: | 40 - 200 % | for measurement on coniferous wood using the active electrode MH 34 |
| Air Humidity, position »M«: | 7 - 98 % R.H. | with active electrodes RF-T 28, RF-T 31, RF-T 32 and RF-T 36 |

Temperature 1, position »200«: -200 - +200 °C with temperature probes PT 100
Temperature 2, position »600«: -200 - +600 °C with temperature probes PT 100
Temperature 3, position »M«: -20,0 - +200 °C with infrared sensor IR 40.

If the measured value exceeds the measuring capacity, the figure »1« appears on the left side of the display screen (3).

Dimensions

Plastic casing: Length 140 mm x Width 90 mm x Height 42/50 mm.
Weight: about 220 g without accessory.

General instructions for UNI 1 and UNI 2

Admissible ambient temperatures

Storage: 5 to 40 °C; temporarily -10 to 60 °C

Operation: 0 to 50 °C, short term -10 to 60 °C not condensing

The meter including accessory must not be stored or used in aggressive air or air contaminated by solvents.

General Remark

The instructions for use of the meter and of the electrodes should be carefully observed to avoid measuring errors which may occur when trying to simplify the measuring procedure.

Warning

Make sure in any case prior to drilling holes for measuring probes or before driving electrode pins into walls, ceilings or floors that this happens away from power lines, water pipings or other supply pipes.

Measuring Electrodes and Other Accessory



Active electrode MH 34 (*Ref.No. 3350*)

with integrated measuring circuit, for measurement of high moisture contents in coniferous wood, specially in case of water-borne storage and pre-sorting of freshly cut timber for kiln drying.

Measuring range: 40 to 200 % m.c.



Active electrode B 50 (*Ref. No. 3750*)

with integrated measuring circuit, designed for non-destructive location of moisture concentration in construction materials and moisture distribution in walls, ceilings and floors.

It works according to a patented measuring procedure and generates a concentrated high frequency field with substantial penetration depth.

Measuring range: 0 to 199 digits, classification by table,
0.3 to 8.5 % of dry weight, conversion into % of moisture by table.
0.3 to 6.5 % CM, conversion by table according to material tested.



Active electrode B 60 (Ref. No. 3760)

with integrated measuring circuit, designed for non-destructive location of moisture concentration in construction materials and moisture distribution in walls, ceilings and floors.

It works according to a patented measuring procedure and generates a concentrated high frequency field with substantial penetration depth.

With built-in limit value selector and acoustic signal generator.
Setting range: 20 to 140 digits.

Measuring ranges: 0 to 199 digits by table.
0.3 to 8.5 % of dry weight conversion by table according to material tested.
0.3 to 6.5 % CM, conversion by table according to material tested.



Active electrode MB 35 (*Ref. No. 3770*)

with integrated measuring circuit, designed for surface measurement of concrete, in particular prior to coating or gluing.

Measuring range: 1 to 8 % m.c. of dry weight according to oven test, direct display, no conversion table required.



Test Standard (*Ref. No. 6073*)

for checking the active electrode MB 35.



Special electrode RF-T 28 (*Ref.No. 3155*)

with integrated measuring circuit, for measurement of air humidity and air temperature, complete with connection cable.

Measuring range: 7 to 98 % R.H. and -10 to +80 °C

Response time: about 20 seconds for 90 % of the humidity difference at an ambient temperature of 20 °C, or about 120 seconds for 90 % of temperature variation.



Filter Cap (*Ref. No. 3156*)

of sintered bronze for use with electrode RF-T 28 in dust laden air or at high air speed.



Special electrode RF-T 31

for measurement of atmospheric moisture, water activity value or equilibrium moisture in bulk materials and solid substances, e.g. brickwork and other building materials.

Measuring range: 7 to 98 % R.H.
-10 to +80 °C.

Sensor tube: dia. 10 mm

Sintered filter tip 32 mm long.

Insertion length 250 mm (Ref. No. 3131)

Insertion length 500 mm (Ref. No. 3132)



Bore hole adapter

with closing plug, for use with plug-in sensor RF-T 31 for equilibrium moisture measurement in brick-work or building materials.

For bore holes up to 150 mm in depth (Ref. No. 5615)

For bore holes up to 250 mm in depth (Ref. No. 5625)

For bore holes up to 500 mm in depth (Ref. No. 5650)



Blade Sensor RF-T 32

for measurement of atmospheric humidity, water activity value and equilibrium moisture in paper, leather, textile and tobacco stores, etc.

Measuring range: 7 to 98 % R.H.
-10 to +80 °C.

Flat elliptical probe abt. 10 x 4 mm.

Insertion length 250 mm (*Ref. No. 3133*)

Insertion length 500 mm (*Ref. No. 3134*)



Sensor Check

Test and calibrating box for

Probe RF-T 28 (*Ref. No. 5728*)

Probe RF-T 31 (*Ref. No. 5731*)

Probe RF-T 32 (*Ref. No. 5732*)

Test and Calibrating Fluid

for checking and recalibrating all electrodes type RF-T.

Package of 5 ampoules of test fluid for sensor check, including absorbing fleece, sufficient for 5 tests or recalibrations.



SCF 30 for the range of 10 to 50 % R.H. (*Ref. No. 5753*)

SCF 70 for the range of 50 to 90 % R.H. (*Ref. No. 5757*)

SCF 90 for the range of 80 to 98 % R.H. (*Ref. No. 5759*)



Special electrode RF-T 36 (*Ref. No. 3136*)

for measurement of air humidity and air temperature, water activity value or equilibrium moisture in rooms, warehouses or solid substances (e.g. concrete, subflooring, masonry, etc.)

Measuring Range: 5 to 98 % R.H.
-5 to +60 °C

Dimensions: 82 x 80 x 55 mm

Sensor tube: length 55 mm, dia. 12 mm

Infrared Surface Temperature Sensor IR 40

(Ref. No. 3150)



Contactless temperature measurement from -20 to +199.9 °C, resolution 0.1 °C, emissivity permanently set at 95 %, ratio of measured area to distance 2.5:1 (Ø 45 mm at a distance of 100 mm), sensor length 185 mm x 36 x 33 mm, coiled cable 320/1200 mm.

An ideal sensor for detection of heat bridges, determination of the dew point temperature, measurement of live, moving or vibrating components as well as measurement of components with low heat capacity, e.g. wood, glass, insulating materials, for location of the position of the heating tubes of a floor heating, etc.

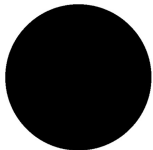

Matt-black stickers IR 30/E 95 (Ref. No. 5833)

Measurement spot 30 mm Ø, emissivity 95 %, e.g. for measurement of metallic surfaces.

Pt 100 Temperature Probes



Temperature Probe ET 10 (Ref. No. 3165)

Robust stick-in temperature probe for solid and bulk materials and liquids, measuring range -50 to +250 °C .



Temperature Probe TT 40 (Ref. No. 3180).

Robust immersion and combustion gas temperature probe with long sensor tube, measuring range -50 to +350 °C



Temperature Probe LT 20 (Ref. No. 3190)

Quick responding air/gas temperature probe with long sensor tube, measuring range -20 to +200 °C.



Temperature Probe TT 30 (Ref. No. 3185)

Robust immersion and combustion gas temperature probe with short sensor tube, measuring range -50 to +350 °C.



Temperature Probe ET 50 (Ref. No. 3160)

Quick responding air/gas temperature probe for soft solid substances, bulk materials and fluids, measuring range -50 to 250 °C.



Temperature Probe OTW 90 (Ref. No. 3175)

Angled special surface temperature probe, e.g. for veneer presses, etc., measuring range -50 to +250 °C.



Temperature Probe OT 100 (Ref. No. 3170)

Spring loaded, low mass surface temperature probe, e.g. for wall surfaces, etc., measuring range -50 to +250 °C.



Silicone Heat Conducting Paste (*Ref. No. 5500*)

To improve heat transmission on rough surfaces or where there are contact problems. Unconditionally recommended with OT 100.

Flexible Temperature Probes with Teflon insulated connection cable, for solid and bulk materials as well as liquids up to 120 °C.



FT 2 with Teflon cable 2 m long
(*Ref. No. 3195*)

FT 5 with Teflon cable 5 m long
(*Ref. No. 3196*)

FT 10 with Teflon cable 10 m long
(*Ref. No. 3197*)

FT 20 with Teflon cable 20 m long
(*Ref. No. 3198*)

Use of Active Electrode MH 34

for measurement of high moisture contents (above 40 % m.c.) in coniferous wood

The active electrode MH 34 has been developed specially for measurement of very high moisture contents in coniferous wood (pine, fir, spruce). It is suitable particularly for pre-sorting freshly cut timber for kiln drying and for monitoring water-borne storage.

The measuring range extends from 40 to 199 % m.c. and the reading is displayed direct in per cents of moisture. Moisture values below 40 % m.c. are beyond the measuring capacity of this special electrode and readings below 40 % m.c. should, therefore, be disregarded. For measurements in the range below 40 % m.c. the electrodes M 18 and M 20 should be used.

The active electrode MH 34 is equipped and also adjusted to pins 23 mm in length, and the readings obtained represent the average moisture content of those section of the board or piece of wood penetrated by the pins. We do not recommend using longer or shorter pins as this will affect the accuracy of reading.

Press, or drive cautiously, both pins into the wood to be measured until both cap nuts touch it. Connect electrode to the meter socket (1) (UNI 1) or (2) (UNI 2) and set selector switch (3) (UNI 1) or (4) (UNI 2) to position »M«. Then press measuring key (4) (UNI 1) or (5) (UNI 2) and read result in per cent of moisture.

When withdrawing the electrode, the pins can be loosened by slight sideways rocking movements across the grain. The cap nuts should be tightened by means of a spanner prior to a series of measurements.

Instructions For Non-Destructive Measurement of the Moisture Content of Building Materials Using the Electrodes MB 35 and B 50/B 60

Set selector switch (3) (UNI 1) or (4) (UNI 2) to position »M«.

Connect electrode to meter socket (1) (UNI 1) or (2) (UNI 2) and apply it as described hereinafter. Press measuring key (4) (UNI 1) or (5) (UNI 2) and read result displayed by LCD readout (2) (UNI 1) or (3) (UNI 2).

Active Electrode MB 35

The active electrode MB 35 has specially been developed for surface moisture measurement on concrete and sub-floorings and are suitable particularly for moisture checks prior to coating or gluing. The measuring range extends from 1.0 to 8.0 % of dry weight (according to oven test). The reading is displayed direct in per cent of moisture.

The electrode is fitted, as standard equipment, with the surface measuring caps M 20-OF 15 with elastic contact pads of conductive plastic material. The pads are glued on their support which in turn are screwed on the electrode handle. Make sure that the measuring caps are properly screwed down. Exchange the elastic measuring pads in case of wear or damage. Fix the new pads on the support plate by means of a commercially available instant adhesive on cyanate basis.

Use of active electrode MB 35

Connect electrode to the meter and press the measuring pads firmly on the concrete. Press measuring key and read off result in per cent of dry weight. The surface of the concrete should be cleaned from dust and separating agents or other contaminations to ensure correct measuring results.

Active Electrode B 50 und B 60

The active electrodes B 50 and B 60 are dielectric moisture sensor with integrated circuitry. It is intended specifically for determining moisture absorption and moisture distribution in building materials such as for example brickwork, concrete, screed, wood, insulating materials, etc.

The basis of measurement is the dielectric constant measurement method. Between the ball electrode and the material to be measured with which it comes into contact, a measurement field is set up, which is affected by the density of the building material to be measured and its moisture content. If the density of the material is constant, changes in the capacity field can be matched to a change in the moisture content of the material being measured.

The measuring range extends from 0 to 199 digits, i.e. the displayed values are relative values. They indicate the distinction between dry and moist building material. The higher the measured value, the higher the moisture content of the material being measured. Drawing conclusions about the actual moisture content in per cent from the relative measured is only permissible in the case of a normal drying process.

The bulk density of the building material to be measured is in this case a factor of influence which has to be taken into account. High bulk densities lead to higher displayed values, independently of the moisture content.

Use of active electrode B 50 and B 60

In order to avoid influencing of the measurement result by the hand of the operator, the electrode should only be held by its lower half during checking and measurement. The upper half of the electrode must remain free.

Special feature of the active electrode B 60

The active electrode B 60 is equipped with a selector switch to set a limit value. It allows in conjunction with the also incorporated acoustic signal generator judgement of the tested building material without direct sight on the LCD readout.

Whenever the readings exceed the preset limit value, a whistle signal sounds.

In the range between 30 and 70 digits, the signal tolerance is ± 2 digits, and in the range between 80 and 140 digits ± 3 digits.

Checking

Unless it is permanently fixed, push the ball rod into the socket on the top of the electrode and connect the cable to the measuring instrument. Hold the electrode in the air and press the measuring key of the measuring instrument. It must display a value between -5.0 and 5.0 digits. If it fails to display an admissible value, increase or, as the case may be, reduce the reading by slightly turning the potentiometer located behind an opening in the upper half of the grey plastic handle of the active electrode by means of a small screwdriver.

Measurement

Press the measuring key of the moisture meter and bring the electrode ball into contact with the surface to be tested. The electrode ball must be in firm contact with the material. As far as possible the electrode should be held perpendicularly to the surface being measured. In corners measurement is only possible up to a distance of approx. 4 - 5 cm from the edge. The list below is intended to serve as a guide to the displayed values to be expected in practice and their classification:

| | | |
|---------------------------|-------|------------------|
| Wood | dry | 25 - 40 digits |
| | moist | 80 - 140 digits |
| Living area | dry | 25 - 40 digits |
| brickwork | moist | 100 - 150 digits |
| Basement brickwork | dry | 60 - 80 digits |
| | moist | 100 - 150 digits |

Depending on the bulk density, displays of more than 130 digits would indicate the presence of free water. In the case of covered metal parts (reinforcing steel, pipes, ducting, plaster supporting strips, etc.) even if the environment is otherwise dry the display jumps to approximately 80 digits (if the

covering is very thin, even higher). This should be taken into account when assessing the displayed values.

Display Values (Digits) in Relation to the Material Bulk Density

| Density (specific wt.) of the building material kg/m ³ | Corresponding Relative Air Humidity | | | | | |
|----------------------------------------------------------------------------------|-------------------------------------|---------------|-------------|----------|---------------|------------------|
| | 30 — 50 — 70 — 80 — 90 — 95 — 100 | | | | | |
| | Display in Digits | | | | | |
| | very dry | normal dry | semi dry | moist | very moist | wet |
| up to 600 | 10 - 20 | 20 - 40 | 40 - 60 | 60 - 90 | 90 - 110 | more than 100 |
| 600 -1200 | 20 - 30 | 30 - 50 | 50 - 70 | 70 - 100 | 100 - 120 | more than 120 |
| 1200 -1800 | 20 - 40 | 40 - 60 | 60 - 80 | 80 - 100 | 110 -130 | more than 130 |
| above 1800 | 30 - 50 | 50 - 70 | 70 - 90 | 90 - 120 | 120 - 140 | more than 140 |

Display Values (Digits) in Percents of Weight

| Display (Digits) | | 40 | 50 | 60 | 70 | 80 | 90 | 100 | 110 | 120 | 130 |
|-----------------------------|----------|-----|-----|-----|-----|-----|-----|------|------|-----|-----|
| Cement mortar | weight % | 1.8 | 2.2 | 2.7 | 3.2 | 3.6 | 4.1 | 4.5 | 5.0 | 5.5 | 5.9 |
| Anhydrite screed | weight % | 0.1 | 0.3 | 0.6 | 1.0 | 1.4 | 1.8 | 2.2 | 2.5 | 2.9 | 3.3 |
| Concrete B 15, B 25, B 35 | weight % | | 1.3 | 1.9 | 2.5 | 3.2 | 3.8 | 4.4 | 5.0 | 5.6 | 6.2 |
| Cement mortar | weight % | 1.8 | 2.7 | 3.5 | 4.6 | 6.0 | 7.0 | 7.8 | | | |
| Lime mortar | weight % | 0.6 | 2.0 | 3.3 | 4.5 | | | | | | |
| Lime-cement plaster mixture | weight % | 2.2 | 3.6 | 5.0 | 6.4 | 7.8 | 9.2 | 10.6 | 11.0 | | |
| Gypsum plaster | weight % | 0.3 | 0.5 | 1.0 | 2.0 | 3.5 | 6.5 | 10.0 | | | |

Readings in digits depending on the moisture in weight per cent. The displayed values are guide values. They refer to a depth of 1.5 to 3 cm in the case of a measurement on the surface and a normal drying process. Weight percentages are according to an oven test at 105 °C, for gypsum and anhydrite binders at 40 °C.

Note

The references and tables concerning permissible or customary moisture proportions in practice contained in the Operating Instructions and the general definitions have been taken from the specialist literature. No guarantee of correctness can therefore be given. The conclusions each user may draw for his own purposes from the measurement results are based on the individual circumstances and the knowledge he has gained from his professional activities.

Instructions for Moisture Measurement in Building Materials on the Basis of the Measurement of the Relative Air Humidity

using the active electrodes RF-T 31 and RF-T 36

Set selector switch (3) (UNI 1) or (4) (UNI 2) to position »M«.

Connect selected active electrode to the meter socket (1) (UNI 1) or (2) (UNI 2).

Press measuring key (4) (UNI 1) or (5) (UNI 2) and read off result displayed (in % R.H.) by the LCD readout (2) (UNI 1) or (3) (UNI 2).

Technical specifications

Measuring range:

5 to 98 % R.H. for short periods.

For continuous or long period measurements in the range above 80 % R.H., a special calibration is required for the measuring sensors.

Admissible operating temperature for the meter and the electrodes:

-10 °C to +60 °C for short periods,

0 °C to +50 °C for long periods.

Admissible ambient conditions for the storage of the meter and the electrodes:

-10 °C to +60 °C for short periods

5 °C to +40 °C for long periods.

5 % to 98 % R.H. for short periods *)

35 % to 70 % R.H. for long periods *)

*) not condensing

Measurement of the Relative Air Humidity / Water Activity in Building Materials

This method is usually used for depth measurements in old buildings (sandstone, rough stone, wet walls with efflorescence, etc.) where measurements based on the resistance measurement method give no reproducible results. For this purpose the active electrode RF-T 31 with special tube lengths of 250 and 500 mm is used. In the case of measurements over a longer period at several points or at various depths, the drilled holes should be secured and closed by means of a masonry sleeve / bore hole adapter.

The method of measuring the relative air humidity / equilibration moisture in screeds is chiefly used in Great Britain and the Scandinavian countries. The active electrode RF-T 36 has been specially developed for this. Compared with non-destructive measurement or resistance measurement it is however very time-consuming and required relatively large holes. Reliability for the floor layer/ finisher is but on the other hand very good, if it is possible to wait for moisture balance (relative air humidity of the surroundings equal to that of the hole). This method also increases reliability in cases where there is not adequate information concerning the composition of the screed.

Use of the active electrode RF-T 31

For deep measurements in building materials by means of the relative air humidity, in addition to the probe with a sensing tube length of 250 or 500 mm a bore hole adapter consisting of a masonry sleeve of 150, 250 or 500 mm length should be used.

For the measurement a blind hole of 16 mm diameter should be drilled down to the required measuring depth. It is important to use a sharp drill, with a high number of impacts and low speed. If the hole should heat up strongly it is necessary to wait for temperature equalization (30 - 60 minutes) before taking the measurement. The hole should be cleared of dust (by blowing). Then the hole adapter should be introduced as far as the end of the hole, pressed in and at the same time turned to the right. The adapter should be tightened to such an extent that the entire screw thread sits firmly in the brickwork, concrete, etc. Then the closure rod for sealing or the electrode RF-T 31 should be inserted.

The moisture balance in the hole is achieved when temperature equalization exists (the same temperature in the hole, adapter and sensor tube) after approximately 30 minutes. Then the measurement value can be read off and assessed by means of the following graph.

Use of the active electrode RF-T 36

For the measurement a blind hole of 12 - 14 mm diameter and minimum 25 mm and maximum 50 mm deep must be drilled. The depth of drilling depends on the required measurement depth or thickness of the screed. Blow the hole clear of dust and wait for temperature equalization. Push the piece of foam enclosed on to the electrode tube of the probe and adjust the distance and to seal it, then introduce it into the hole.

The moisture balance in the hole is achieved when temperature equalization exists (the same temperature in the hole, adapter and sensor tube) after approximately 30 minutes. Then the measurement value can be read off and assessed by means of the following graph.

Table of Comparison Air Humidity - Structural Moisture

Air relative humidity % H.R.

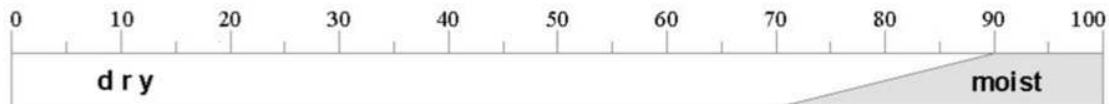

Cement flooring %

1,5

2

2,5

3

Outdoor humidity conditions

Indoor humidity conditions

Centrally heated rooms

Damage to the Sensor

The sensor can be rendered irreparable as a result of various mechanical or environmental influences. These include in particular:

- direct contact between the sensor and the fingers,
- direct contact with solid or adhesive materials or objects,
- measurement in atmospheres containing solvents, oil vapours and other high proportions of harmful substances.

Measuring Errors

Measurements below 20 % relative humidity and above 80 % relative humidity should be avoided over a long period as far as possible. In order to make exceeding the measuring range particularly easy to recognize, above 98 % relative humidity a »1« appears on the left hand side of the display instead of the measured value. Other measured value distortions can occur as a result of screening with parts of the body (e.g. the hand) or blowing or speaking/breathing in the direction of the sensor.

Note

The sensor is not designed for continuous measurements above 80 % relative humidity. If continuous measurements have to be made in extreme regions special adjustments should be made by means of sensorcheck and a calibration liquid.

Instructions for Air Humidity Measurement

using the active electrodes RF-T 28, RF-T 31, RF-T 32 and RF-T 36

Set selector switch (3) (UNI 1) or (4) (UNI 2) to position »M«.

Connect electrode to the meter socket (1) (UNI 1) or (2) (UNI 2).

Press measuring key (4) (UNI 1) or (5) (UNI 2) and read off result displayed (in % R.H.) by the LCD readout (2) (UNI 1) or (3) (UNI 2).

Technical Specifications

| | |
|--------------------------------------------------------------------------------|-------------------------------------------------------------------------------------------------------------------------------------------------------------------------------|
| Measuring range: | 5 to 98 % R.H. for short periods. For continuous or long period measurements in the range above 80 % R.H., a special calibration is required for the measuring sensors. |
| Admissible operating temperature for the meter and the electrodes: | -10 °C to +60 °C for short periods, 0 °C to +50 °C for long periods. |
| Admissible ambient conditions for the storage of the meter and the electrodes: | -10 °C to +60 °C for short periods 5 °C to +40 °C for long periods. 5 % to 98 % R.H. for short periods *) 35 % to 70 % R.H. for long periods *) *) not condensing |

Use of the active electrode RF-T 28

Hold the electrode in the air or fasten it at the desired measurement site and start the measuring process. For particularly precise measurements, especially below the usual room temperature (abt. 20 °C) or if there are substantial temperature differences between the electrode or meter and their surroundings, they should be exposed to the ambient atmosphere for approx. 10 - 15 minutes until temperature equalization. The sensor adapts itself to the surrounding atmosphere even in the switched-off condition.

Response time of the air humidity sensor

The response time of the sensor is very short so even gently moving air (generated by a slightly opened door or a window being not tight) may affect the reading. This is why no absolute standstill of the value displayed can be achieved unless the sensor is installed in an airtight box.

The response time of the sensor in gently moving air is as follows for ambient temperatures from 20 °C to 25 °C

for 90 % of the humidity difference, approx. 20 seconds,
for 95 % of the humidity difference, approx. 30 seconds.

The adjustment time in still air or at very low air movement can be reduced by moving or turning the electrode (ventilating the sensor).

Filter cap for electrode RF-T 28

For measurements in dust laden air, at emission of harmful substances or at high air speed, a sintered filter cap can be fitted after removal of the protection cap with venting slots. For protection of the sintered filter, fix then the plastic cap again.

If the filter becomes dirty it can be washed in residue-free cleaning liquid and/or blown from inside outwards with compressed air. With the sintered filter inserted, the response time will be considerably prolonged.

Use of the active electrode RF-T 31

The sensor RF-T 31 can be supplied with insertion length of 250 or 500 mm and is mainly used for measuring the relative air humidity or the AW value in places difficult of access, in air ducts, in bulk materials or, in combination with a special adapter, in solid substances (e.g. brickwork, concrete, etc.).

Hold the electrode at the point of measurement in the air or insert it or attach it at the required point with a fixture and start the measurement process. For particularly precise measurements, in particular at temperatures below usual room temperature (abt. 20 °C) or when there are considerable temperature differences between the actual temperature of the electrode or of the measuring instrument and that of the surrounding atmosphere, the instrument with its electrode should be exposed to the ambient climate for approximately 10 to 15 minutes or until temperature equalization.

Here too, the sensor adapts itself to the surrounding atmosphere without being switched on. If it becomes dirty, the sintered filter cap can be washed in residue free cleaning liquid and/or blown from inside outwards with compressed air.

Response time of the air humidity sensor RF-T 31

The response time is delayed by the sintered filter cap. In exceptional cases it can be unscrewed. However, if this is done the danger of damage to the sensor is increased considerably. The response time of the air humidity sensor in moving air, with an ambient temperature of 20 to 25 °C is

- for 90 % of the moisture difference without filter approx. 20 sec., with filter approx. 5 min., and
- for 95 % of the moisture difference without filter approx. 30 sec., with filter approx. 15 min.

Use of the active electrode RF-T 32

The sensor RF-T 32 is available with insertion lengths of 250 and 500 mm and is mainly used for measuring the relative air humidity or the AW value in places difficult of access or in stacks of paper, leather, textile, tobacco, etc.

Hold the electrode at the point of measurement in the air or place it at the required point and start the measurement process. For particularly precise measurements, in particular at temperatures below usual room temperature (abt. 20 °C) or when there are considerable temperature differences between the actual temperature of the electrode or of the measuring instrument and that of the surrounding atmosphere, the instrument with its electrode should be exposed to the surrounding atmosphere for approximately 10 to 15 minutes or until temperature equalization. The sensor adapts itself to the surrounding atmosphere even if it is switched off.

Note

If it becomes dirty, the filter cloth inserted cannot be washed in cleaning liquids and /or blown clear with compressed air from inside to outside. Therefore its use in dusty media should be avoided. Cleaning should only be carried out from outside using a soft brush.

Response time of the air humidity sensor RF-T 32

The response time is delayed by the filter cloth and the metal tube. The response time of the air humidity sensor in moving air, with an ambient temperature of 20 to 25 °C is:

- approx. 3 minutes for 90 % of the humidity difference, and
- approx. 10 minutes for 95 % of the humidity difference.

Use of the active electrode RF-T 36

The electrode RF-T 36 was developed among other things for semi-stationary (electrode remains at the measuring point - display unit is mobile when in use) air humidity and air temperature measurement in interiors, storage bays, etc.

Attach the electrode at the measuring location or at the required point and start the measuring process. For particularly precise measurements, in particular at temperatures below room temperature (abt. 20 °C) or if there are significant temperature differences between the temperature of the electrode itself and that of the surrounding atmosphere (measurement immediately after assembly) the electrode should be exposed to the surrounding atmosphere for approximately 10 to 15 minutes or until temperature equalization. The sensor adapts itself to the surrounding atmosphere even while being switched-off.

Response time of the air humidity sensor RF-T 36

The response time is delayed by the filter cap. In exceptional cases it can be unscrewed. However, if this is done the danger of damage to the sensor is increased considerably. The response time of the air humidity sensor in moving air, with an ambient temperature of 20 to 25 °C is:

- approx. 20 sec. for 90 % of the humidity difference without filter or
- approx. 3 min. with filter, and
- approx. 30 sec. for 95 % of the humidity difference without filter, or approx. 10 min. with filter.

Note

If it becomes dirty, the inserted filter cloth can only be washed in distilled water and/or blown clear with slight excess pressure from inside outwards. Therefore its use in very dusty media should be avoided. Preferably the cleaning should be carried out from outside using a soft brush.

**Synoptical table of dew point temperatures
as dictated by the air temperature and air relative humidity**

| Air temperature °C | Dew point temperature in °C at an air relative humidity of | | | | | | | |
|-----------------------|------------------------------------------------------------|-------|------|------|------|------|------|-------------------------------------------------------------------|
| | 30 % | 40 % | 50 % | 60 % | 70 % | 80 % | 90 % | Saturation moisture = quantity of water in g/m ³ |
| | °C | °C | °C | °C | °C | °C | °C | |
| +30 | 10,5 | 14,9 | 18,5 | 21,2 | 24,2 | 26,4 | 28,5 | 30,4 |
| +28 | 8,7 | 13,1 | 16,7 | 19,5 | 22,0 | 24,2 | 26,2 | 27,2 |
| +26 | 7,1 | 11,3 | 14,9 | 17,6 | 19,8 | 22,3 | 24,2 | 24,4 |
| +24 | 5,4 | 9,5 | 13,0 | 15,8 | 18,2 | 20,3 | 22,2 | 21,8 |
| +22 | 3,6 | 7,7 | 11,1 | 13,9 | 16,3 | 18,4 | 20,3 | 19,4 |
| +20 | 1,9 | 6,0 | 9,3 | 12,0 | 14,3 | 16,5 | 18,3 | 17,3 |
| +18 | 0,2 | 4,2 | 7,4 | 10,1 | 12,4 | 14,5 | 16,3 | 15,4 |
| +16 | -1,5 | 2,4 | 5,6 | 8,2 | 10,5 | 12,5 | 14,3 | 13,6 |
| +14 | -3,3 | -0,6 | 3,8 | 6,4 | 8,6 | 10,6 | 12,4 | 12,1 |
| +12 | -5,0 | -1,2 | 1,9 | 4,3 | 6,6 | 8,5 | 10,3 | 10,7 |
| +10 | -6,7 | -2,9 | 0,1 | 2,6 | 4,8 | 6,7 | 8,4 | 9,4 |
| +8 | -8,5 | -4,8 | -1,6 | 0,7 | 2,9 | 4,8 | 6,4 | 8,3 |
| +6 | -10,3 | -6,6 | -3,2 | -1,0 | 0,9 | 2,8 | 4,4 | 7,3 |
| +4 | -12,0 | -8,5 | -4,8 | -2,7 | -0,9 | 0,8 | 2,4 | 6,4 |
| +2 | -13,7 | -10,2 | -6,5 | -4,3 | -2,5 | -0,8 | 0,6 | 5,6 |
| 0 | -15,4 | -12,0 | -8,1 | -5,6 | -3,8 | -2,3 | -0,9 | 4,8 |

Test and Calibrating Instructions for the Relative Humidity Circuitry of the Electrodes RF-T 28, 31 and 32 Using the Sensorcheck

General Comments

In general one has to differentiate between a test, a possibly necessary re-calibration and a special calibration for continuous measurement of more than 80 % humidity. Three test and calibrating liquids are available for the ranges of 10 to 50 %, 50 to 90 % and 80 to 98 %. The latter liquid is intended for special calibration of the high humidity range and is not to be used for general test or calibrating purposes. For testing or calibration of the standard moisture range, the liquid SCF 70 is to be employed.

During testing or calibration, the electrode, the sensorcheck and the liquid must be of the same temperature. This temperature must be maintained throughout the procedure. Changes of temperature may be caused by a draft, by breathing or blowing or by holding the electrode tube, the sensorcheck or the liquid-ampoule in one's hand. Wrapping these components in Styropor or similar insulating material is recommended.

Please follow the instructions stated on the wrapper of the liquid-ampoule regarding test, calibration and nominal value data closely.

Testing

Different sensorcheck top pieces are required for each of the three types of electrodes. The following test sequence must be observed:

1. Unscrew sensorcheck top from bottom.
2. **Electrode RF-T 28:** Carefully pull-off the protective cap. If used, remove the dust cap first.
Electrode RF-T 31: Unscrew the sinter filter cap and withdraw it carefully **only along the axis of the tube extension**. Tilting the sinter filter may cause damage to the moisture sensor.
Electrode RF-T 32: This electrode requires no special preparation. Do not dismantle it.
3. **Electrode RF-T 28:** Plug the top of the sensorcheck to the electrode and push it on lightly (conical fit).
Electrode RF-T 31: Plug the top of the sensorcheck over the moisture sensor of the electrode and screw to the thread of the electrode tubing. **Use no force and do not tighten it securely.**
Electrode RF-T 32: Insert the oval tubing of the electrode, perforated side downward, horizontally into the top part of the sensorcheck. Make sure that the perforations are inside the sensorcheck. To avoid temperature change, do not handle the metal tubing of the electrode unnecessarily.
4. Store the electrode, the sensorcheck and the test liquid at a temperature-stable location until all components have assumed the temperature given on the packaging of the test-ampoule (e.g. $23\text{ °C} \pm 2\text{°C}$).
5. Remove a piece of fleece from the plastic bag and place it in the bottom section of the sensorcheck. Close the plastic bag containing the remaining pieces of fleece tightly.

6. Pick an ampoule containing the desired type of test liquid. Hold it vertically and tap it lightly to return all liquid into the lower part of the ampoule. Hold the ampoule tightly and break its neck off at the white marking. Pour all of the liquid in the ampoule onto the fleece in the lower part of the sensorcheck.
7. Screw the lower part of the sensorcheck onto the upper part. To prevent a change of temperature hold the items as briefly as possible or wear gloves.
8. Connect the electrode to the Hydromette by means of its cable.
9. **Electrode RF-T 28:** While avoiding a change of temperature, allow the electrode to be exposed to the atmosphere of the sensorcheck as stated on the packaging (e.g. 10 min. \pm 1 min.).
Electrode RF-T 31: Proceed in the same way as with the electrode RF-T 31.
Electrode RF-T 32: When testing the RF-T 32 electrode, **double** the exposure time stated on the packaging of the ampoule (e.g. 20 min. \pm 2 min.). Avoid a change of temperature.
10. At the end of the above stated exposure time, press the measuring key of the Hydromette and obtain an air humidity reading. A deviation of \pm 2 % from the nominal value given on the package of the ampoule is permissible.

Recalibration

Re-calibration of the sensors used with the electrodes RF-T is hardly ever necessary. Existing deviations of measurement are almost always caused by improper storage of the electrode in surroundings which are too dry or too moist. Prior to every recalibration of the electrode, it should be exposed to a conditioning process. This means exposing the electrode to an average relative humidity of from 45 % to 65 % R.H. for 24 hours. If the measured humidity is too low by more than 5 %, it is suggested to expose the electrode to a high humidity of 70 % to 75 % R.H. for the first 12 hours.

If the measured humidity is too high, a similar conditioning process in a dry climate of 40 % to 45 % R.H. is recommended. At completion of such a conditioning process, a re-calibration may be found unnecessary, as the original deviation had been caused by the effect of sorption.

If re-calibration is needed, the test and calibration fluid SCF 70 should be used. Preparation and general procedure is as outlined in paragraph »*Testing*« 1 to 9 c.

Re-calibration is done by means of a small straight screwdriver with a maximum blade width of 2 mm (3/16 inch). A trimpotentiometer is located behind an opening in the middle of the black plastic handle. By careful, clockwise turning of the trimpotentiometer, the measured humidity can be increased; it can be decreased by turning counter-clockwise. One full rotation corresponds approximately to a change of 7 % R.H. The re-calibration should begin exactly at the end of the exposure time of 10 resp. 20 minutes and should take no longer than 2 to 4 minutes.

Special Calibration

Special calibration may become necessary if continuous measurements of high humidity (more than 80 % R.H.) or of very low humidity (less than 35 % R.H.) are to be conducted. Test liquids SCF 90 and SCF 30 are available for this purpose. To eliminate measuring or calibrating mistakes caused by the sorption effect, it is necessary to allow an exposure time of 6 to 7 hours for the electrode RF-T 32.

This special calibration is done, under consideration of the longer exposure times, following the instructions given in paragraphs »*Testing*« and »*Re-Calibration*«.

To return a specially calibrated electrode to normal usage, it must be re-calibrated according to paragraph »*Re-Calibration*« after it had been subjected to a conditioning period of 24 hours.

Operating Instructions for Temperature Measurement

Measurement using active electrodes RF-T 28, RF-T 31 and RF-T 32

Set selector switch (3) (UNI 1) or (4) (UNI 2) to position »200 °C«.

Connect electrode to meter socket (1) (UNI 1) or (2) (UNI 2).

Press measuring key (4) (UNI 1) or (5) (UNI 2) and read off result in °C displayed by the LCD readout (2) (UNI 1) or (3) (UNI 2).

Measurement using PT 100 temperature probes

Set selector switch (3) (UNI 1) or (4) (UNI 2) to position »200 °C« or »600 °C«.

Connect temperature probe to meter socket (1) (UNI 1) or (2) (UNI 2).

Press measuring key (4) (UNI 1) or (5) (UNI 2) and read off result in °C displayed by the LCD readout (2) (UNI 1) or (3) (UNI 2).

Measurement using active electrode IR 40

Set selector switch (3) (UNI 1) or (4) (UNI 2) to position »M«.

Connect infrared temperature probe to the meter socket (1) (UNI 1) or (2) (UNI 2).

Adjust temperature probe to the desired measuring spot and press measuring key (4) (UNI 1) or (5) (UNI 2). Read off result in °C.

General Information About Temperature Measurement

A temperature balance must be achieved between the measuring sensor and the object to be measured, for correct readings to be made. This is easy to achieve when measuring liquids in large quantities or large objects with a high heat content. One must ensure that the sensor tube and head are not affected by another temperature such as ambient air temperature.

Therefore, it is recommended that the sensor be totally immersed or a screen be fitted to the tube. This screen can be made of polyester or of foam rubber about 3 cm dia., and sufficiently long to protect the exposed length of the tube which will be pushed through the middle. In the case of surface measurements with temperature probe OT 100, the block of polyester or rubber foam with a length of side of at least 30 mm will be sufficient to protect against convection heat or cold when taking temperature measurements on walls.

In the case of materials which are poor heat conductors or of low heat content (e.g. rockwool, glasswool, etc.) it is often not possible to achieve a correct temperature measurement with electrical sensors. To obtain utilizable results, it may become necessary either to take into account the ambient temperature or to carry out approximate measurements.

When measuring insulating materials whose surface temperature generally corresponds to the ambient temperature, the stick-in temperature probe ET 50 should be used. Measurement or response times do however increase considerably.

Use of the active electrodes RF-T 28, RF-T 31 and RF-T 32

Hold the probe in the air at the measuring location and start the measurement by pressing the measuring key (4) (UNI 1) or (5) (UNI 2). The electrodes RF-T 28, RF-T 31 and RF-T 32 are only suitable for measuring the air temperature (besides of the air humidity) not for temperature measurements on solid material and liquids.

For particularly precise measurements, in particular at temperatures below +10 °C or above +40 °C or if there are significant temperature differences between the temperature of the electrode itself or of the measuring instrument and that of the surrounding atmosphere, the electrode should be exposed to the surrounding atmosphere of the measuring location for approximately 10 to 15 minutes or until temperature equalization.

The measuring range from -10 to +80 °C only applies to the sensor tip (length of the protective cap) of the electrode. The electrode tube with electronics and the measuring instrument may be exposed to temperatures above 50 °C only for a short time. For the instrument and probes if possible do not allow the operating temperature to fall below 0 °C or rise above +50 °C.

Falsification of the measured values can occur by screening with parts of the body (e.g. the hand) or by blowing or speaking/breathing in the direction of the sensor.

The adjustment time of the air temperature sensor for 90 % of the temperature jump is in the case of moving air for the probe RF-T 28 approximately 120 sec., for the probes RF-T 31 and RF-T 32 approximately 5 minutes.

The air temperature sensor adjusts to the surrounding atmosphere also if not switched on.

Use of the Surface Temperature Probe OT 100

The OT 100 is a special probe with low mass for measuring surface temperatures. Coat the sensor head with heat conducting paste and press it against the object to be measured. The sensor head must lie totally flat and in good contact. There must be no air (only a thin layer of heat conducting paste) between the sensor head and the object to be measured.

The response time ranges between 10 and 40 seconds depending on the material to be measured. In order to achieve good results, sufficient heat content and heat conductivity of the material to be measured is indispensable.

Note

Avoid damage to the spring loaded tip of the probe by exerting excessive pressure or by bending the tip.

Use of the Surface Temperature Probe OTW 90

The OTW 90 is an angled special probe with low mass for measuring surface temperatures. It is specially designed for measurements in plate presses with an aperture of at least 17 mm. For measurements on rough surfaces coat the sensor head with heat conducting paste and press it against the object to be measured. The sensor head must lie totally flat and in good contact. There must be no air (only a thin layer of heat conducting paste) between the sensor head and the object to be measured.

The response time ranges between 20 and 60 seconds depending on the material to be measured. In order to achieve good results, sufficient heat content and heat conductivity of the material to be measured is indispensable.

Silicone Heat Conducting Paste

The heat conducting paste is supplied in packages containing 2 tubes of 30 g each. Its purpose is to improve the transfer of heat between the sensor and the object being measured. Temperature measurements with the probes OT 100 and OTW 90 on rough surfaces should generally be carried out in conjunction with heat conducting paste.

Use of the Stick-in Temperature Probe ET 10

The stick-in probe ET 10 is a simple probe for measuring temperatures in liquids and semi-solid materials (e.g. frozen materials), and for measuring core temperatures in pre-drilled holes.

Dip the sensor tip to a depth of at least 4 cm into the liquid or stick it into the material to be measured and take the reading. When measuring core temperatures, keep the hole as small as possible. Remove dust from the hole and wait for heat generated during drilling to dissipate. Coat sensor tip with heat conducting paste, insert and take the reading. Shallow holes can be directly filled with heat conducting paste.

Depending on the material to be tested, the response time lies between approx. 20 seconds (liquids) and 180 seconds.

Use of the Stick-in Temperature Probe ET 50

The stick-in probe ET 50 is a special sensor for measuring temperatures in liquids and soft materials, and for measuring core temperatures in pre-drilled holes.

Dip the sensor into the liquid or insert it into the soft material to be measured, in both cases at least as far as the first swelling (or approx. 6 cm deep), and take the reading. When measuring core temperatures, keep the hole as small as possible. Remove dust from the hole and wait for heat generated during drilling to dissipate. Coat sensor tip with heat conducting paste, insert and take the reading. Shallow holes can be directly filled with heat conducting paste.

Depending on the material to be tested, the response time lies between approx. 10 seconds (liquids) and 120 seconds.

Use of the Air/Gas Temperature Probe LT 20

The LT 20 is a special probe for measuring temperatures in air or gaseous mixtures. Hold measuring tip at least 4 cm deep into the medium to be measured and take the reading. Owing to its length of 480 mm, it is particularly suitable for measurements in air-ducts.

Depending on the speed of the air or gas-flow, the response time lies between 10 and 30 seconds for 10 °C each of change in temperature.

Use of the Immersion and Combustion Gas Temperature Probe TT 30

The immersion probe TT 30 is a special sensor for measuring temperatures in liquids and core temperatures in pre-drilled holes as well as in combustion and waste gas of burners. The sensor tube has a length of 230 mm.

Dip the sensor tip at least 6 cm deep into the medium to be measured, and take the reading. When measuring core temperatures, keep the hole as small as possible. Remove dust from the hole and wait for heat generated during drilling to dissipate. Coat sensor tip with silicone heat conducting paste, insert and take the reading.

Depending on the material to be measured, the response time lies between approx. 10 seconds (liquids) and 180 seconds.

Use of the Immersion and Combustion Gas Temperature Probe TT 40

The immersion probe TT 40 is a special sensor for measuring temperatures in liquids and core temperatures in pre-drilled holes as well as in combustion and waste gas of burners. The sensor tube has a length of 480 mm.

Dip the sensor tip at least 6 cm deep into the medium to be measured, and take the reading. When measuring core temperatures, keep the hole as small as possible. Remove dust from the hole and wait for heat generated during drilling to dissipate. Coat sensor tip with silicone heat conducting paste, insert and take the reading.

Depending on the material to be measured, the response time lies between approx. 10 seconds (liquids) and 180 seconds.

Use of the Flexible Temperature Probes of FT Series

For correct temperature measurement temperature equalization must be created between the measurement sensor and the object being measured. This is easily possible in the case of measurements on liquids in larger quantities or on large objects with high heat retention. Here care must be taken to ensure that the sensor (length of the shrinkable sleeve) is not influenced at certain points by another temperature (surrounding air temperature). Therefore it is recommended paying particular attention to ensuring that in the case of temperatures below 60 °C the sensor be immersed in the medium completely (minimum 6 cm).

For measuring interior temperatures (storage bays, dry kilns, etc.) the sensor should be attached to a well ventilated point.

For measurement in bulk materials, ensure that the complete sensor tip (shrinkable sleeve with at least 10 cm cable) is buried.

The temperature sensors FT can be used up to +120 °C. The teflon cable makes use in slightly corrosive media also possible.

Handling of Infra-Red Surface Temperature Probe IR 40

Technical Specifications

Measuring range: -20 °C to +199.9 °C. **Resolution:** 0.1 °C.

Emission factor: 95 %, permanently set.

Dimensions: Length 185 mm x 36 mm x 33 mm.
Coiled cable 320/1200 mm long.

Admissible ambient conditions

Storage: 5 °C to 40 °C;
80 % R.H. maximum, not condensing

Operation: 0 °C to 50 °C;
90 % R.H. maximum, not condensing.

General Information Concerning Infra-Red Temperature Measurement Technique

All bodies with a temperature above the »absolute zero« (= 0 K or -273 °C) emit infra-red radiation, also known as thermal radiation. The intensity of this thermal radiation serves as an indication of the surface temperature, having regard to the degree of emission. The infra-red measurement head receives the emitted thermal radiation in a contactless manner and converts it into a voltage signal. This signal is converted in the display device into the measurement unit »Degrees Centigrade«.

Advantages over contact measurement

- Very quick response and measurement time
- No removal of heat from the measurement object
- No damage or contamination of the measurement surface
- Measurement of electrically live or moving parts.

Measure

Turn selector switch (3) (UNI 1) or (4) (UNI 2) to position »M«. Insert the plug of the connection cable into the socket (1) (UNI 1) or (2) (UNI 2) and engage by gently turning clockwise. Follow the reverse procedure to remove the plug. **Do not apply force and do not stretch the cable.**

Immediately after pressing the measuring key, the reading is displayed in °C. Depending on the temperature »jump«, the measurement value is instantly displayed or within a few seconds. Fluctuations in the last display digit (1/10 °C) in the range ± 0.2 °C are completely normal. Even the second digit (1 °C) may jump backwards and forwards on account of the sensitivity of the sensor and its extremely quick reactivity. The damping of the display was intentionally omitted.

During the measurement the measuring sensor should be held only at its lower end (cable insert). For accurate readings the sensor tip must have adopted the ambient temperature. With measurements of more than 5 seconds' duration in the immediate vicinity of hot or cold parts (waste gas pipe, radiant heater or refrigeration equipment) the measurement value may be falsified.

After waiting for about 10 - 15 minutes, as dictated by the temperature difference, a new measurement can be taken (temperature equalization between the sensor housing and the ambient temperature). The accuracy of the measurement depends on the temperature uniformity of the measurement device, measurement sensor (all parts e.g. at room temperature) as well as on the relevant degree of emission of the measurement object.

In order to avoid measurement errors and to protect the equipment against damage, the user should not

- press the sensor opening of the measurement sensor directly against the object being measured,
- measure in an atmosphere that is contaminated or contains vapour,
- measure through a strongly heated atmosphere (flickering)

- measure objects directly exposed to strong sunlight (shade the objects),
- measure objects in the immediate vicinity of strongly heat-emitting or cold-emitting equipment (interrupt heat/cold radiation),
- expose the high-quality measurement device to the influence of strong heat or cold sources (transport in the baggage compartment),
- expose the measurement device to high atmospheric humidity (condensing),
- stretch the connecting cable or excessively twist the spiral cable,
- carry out measurements in rapid succession (wait approx. 5 seconds between each measurement),
- perform measurements in the immediate vicinity of electromagnetic or electrostatic sources.

Degree of emission

The measurement sensor is set to a degree of emission of 95 %. This value covers most building materials, synthetic materials, textiles, paper and non-metallic surfaces. The following list is used to estimate the emission factor, which is affected by, among other things, the shine and roughness of the object being measured. Flat and shiny surfaces reduce the degree of emission while rough and dull surfaces increase the degree of emission. Since with metals the emission factor ranges from 10 % to 90 % depending on the surface (shiny, oxidised or rusty), an exact measurement is not possible. It is, therefore, recommended to use special paper stickers with a factor of 95 % for metals or metallically shiny surfaces and objects with variable emission factors.

A correction between the temperature measurement value and the emission factor requires a knowledge of the ambient temperature compensation between the measurement sensor and the ambient temperature.

The correction is calculated according to the following equation:

$$(T_{\text{display}} - T_{\text{ambient}}) \times 100$$

$$+ T_{\text{ambient}} = T_{\text{measurement object}}$$

Degree of emission (%)

Table of degree of emission (%) for the range 0 - 200 °C

| | | | |
|-------------------|-------------|-------------------|------------|
| Asbestos | 95 % | Marble | 90 to 95 % |
| Asphalt | 90 to 95 % | Paints * | 90 to 95 % |
| Bitumen | 98 to 100 % | Paper * | 95 % |
| Brickwork (rough) | 90 to 95 % | Plaster | 90 to 95 % |
| Cement | 90 to 95 % | Plastic materials | 90 % |
| Ceramics | 90 to 95 % | Roofing fabric | 95 % |
| Clay | 95 % | Sand | 90 % |
| Concrete | 95 % | Textiles * | 95 % |
| Earth | 95 % | Wallpaper * | 95 % |
| Glass | 90 to 95 % | Water | 93 % |
| Gypsum | 85 to 90 % | Wood | 90 to 95 % |
| Limestone | 95 % | | |

*) non-metallic

Size of the measurement spot

The measurement spot diameter depends on the distance from the sensor and has a size of 5 mm immediately in front of the measurement sensor opening. The measurement spot diameter increases proportionally in a ratio of approx. 2.5 : 1 the greater the distance between the measurement sensor and object. At a distance of 100 mm the measurement spot diameter is 45 mm. We recommend a measurement distance between the measurement object and sensor of 20 to 50 mm. The relevant diameter can be determined with the aid of the following diagram.

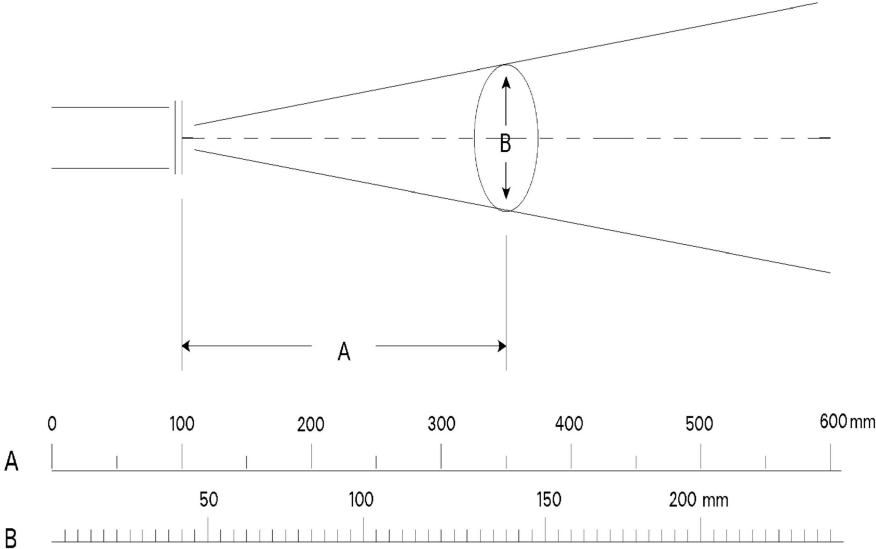

Operating Instructions for Moisture Measurement of Building Materials According to the Resistance Method

- only possible with Hydromette UNI 2 -

Set selector switch (4) to position »B«.

Connect selected measuring electrode to the meter socket (1) by means of the measuring cable MK 8 and drive-in or stick-in electrode into the material to be measured.

Press measuring key (5) and read off result displayed by the LCD readout (3).

Convert reading into per cent of moisture by means of scale graphs listed at the end of this section.

Connection of the Electrodes

Different electrodes can be used with the meter depending on the material to be tested. The electrodes are connected to the meter socket (1) by means of the measuring cable MK 8. On the meter side, this cable is fitted with a BNC plug. Turn clockwise to lock it. To disconnect, turn notched fastening ring anti-clock-wise and draw off plug. ***Do not use force and do not pull on the cable.***



Drive-in Electrode M 20 (Ref. No. 3300)

for measurements on set construction materials (plaster, mortar, etc.), with measuring pins

- 16 mm long (Ref. No. 4610), penetration depth 10 mm
- 23 mm long (Ref. No. 4620), penetration depth 17 mm.



Surface Measuring Caps M 20-OF 15 (Ref. No. 4315)

for moisture measurements on surfaces (e.g. concrete) without damaging the material (only in conjunction with electrode M 20).



Stick-in Electrode pins M 20-Bi 200/300

for measurements in depth of non-apparent construction materials behind another panel, with insulated shank (only in conjunction with the handle of the electrode M 20)

- 200 mm long (Ref. No. 4360)
- 300 mm long (Ref. No. 4365).



Brush Electrodes M 25 (*Ref. No. 3740*)

made of stainless steel, for moisture measurements of hard and soft building materials without contact paste, measuring depth up to 100 mm.



Stick-in Electrodes M 6 (*Ref. No. 3700*)

for testing hard building materials, using contact paste and pre-drilled holes, with pins

- 23 mm long (*Ref. No. 4620*)
- 40 mm long (*Ref. No. 4640*)
- 60 mm long (*Ref. No. 4660*)



Flat Electrodes M6-Bi 200 / 300

for measurements in insulating material of cement flooring through the edge joint (with insulated shank), only for use in conjunction with the handles of the electrodes M 6.

- size 10 x 0.8 x 200 mm (*Ref. No. 3702*)
- size 10 x 0.8 x 300 mm (*Ref. No. 3703*)

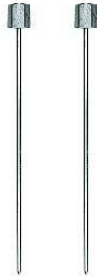

Stick-in Electrodes M 6 – 150 / 250

especially thin and uninsulated pins for testing building and insulating materials through the joint or cross joint of tiles

- Size 150 x 3 mm Ø (*Ref. No. 3706*)
- Size 250 x 2 mm Ø (*Ref. No. 3707*)

(for use with M 6 and M 20 electrodes)



Deep Electrodes M 21-100 / 250

for deep measurements in set building materials, in conjunction with contact paste and pre-drilled holes

- 100 mm long (*Ref. No. 3200*)
- 250 mm long (*Ref. No. 3250*).



Contact Paste (*Ref. No. 5400*)

to ensure good contact between electrode pins and tested building materials. For moisture measurements in hard building materials (cement flooring, concrete, etc.) with electrodes M 6 and M 21.



Active Electrode MB 35 (*Ref. No. 3770*)

with integrated measuring circuit, designed for surface measurement of concrete, in particular prior to coating or gluing.

Measuring range: 2 to 8 % m.c. of dry weight according to oven test.



Carrying Case (Ref. No. 5081)

for storing and transport of the measuring instrument and the standard and optional accessory



Measuring Cable MK 8 (Ref. No. 6210)

for connection of the electrodes M 6, M 18, M 20, M 20-HW
M 20-Bi and M 21



Rechargeable Battery with Charging Unit (Ref. No. 5100)

for use instead of 9 V dry battery supplied as standard.

Test Devices



Test Standard (*Ref. No. 6070*)

for checking the wood moisture measuring section of building materials.



Test Standard (*Ref. No. 6073*)

for checking the active electrode MB 35.

Testing Set Building Materials

For testing soft building materials, the drive-in electrode M 20 should be used, whereas hard building materials such as concrete and cement flooring are to be measured with the stick-in electrodes M 6 or M 21/100, using contact paste.

For penetration measurements, up to a depth of 250 mm, on concrete or masonry, the special electrodes M 21/250 are available. The special stick-in electrodes M 20-Bi available with insulated pins 200 or 300 mm long, are specially designed for measurements of materials hidden beneath another panel or covering, or otherwise inaccessible to other electrodes.

Special measurement caps type M 20-OF 15 are available for surface measurements (e.g. on concrete, etc.). They can be used only in conjunction with the electrode M 20.

Drive-in Electrode M 20

For penetration measurements, up to a depth of 70 mm, on soft, set building materials (gypsum, plaster, etc.), drive electrode pins into the material to be tested (the electrode body is of impact resistant plastic). Take care that both pins of the electrode are driven only into the material to be tested.

When withdrawing the electrode, the pins can be loosened by slight sideways rocking movements. The cap nuts should be tightened by means of a spanner prior to a series of measurements. Loose pins may easily break.

When the meter is supplied with the M 20 electrode as initial equipment, 10 spare pins 16 and 23 mm long (commercial steel nails) are included in the delivery. They can be used for measurements up to a depth of 20 mm or 30 mm respectively. For measurements to greater depths, they can be replaced by longer pins but it should be noted that the liability to breakage or bending increases with the length of the pins.

Surface Measurement Caps M 20-OF 15

For surface measurements on smooth materials, the two hexagonal union nuts have to be unscrewed and replaced by the surface measurement caps. To perform the measurement, the two contact surfaces should be firmly pressed onto the material being measured. The measurement depth is about 3 mm. Particles adhering to the measurement surface should be regularly removed. If the elastic plastic pads should once be damaged, they can be re-ordered and stuck on using a commercially available instant adhesive on cyanate basis.

Measuring errors can be caused by a contaminated or dirty surface (e.g. oil).

Stick-in Electrode M 6

The two electrodes exclusively designed for moisture checks on set building materials are pressed, at approx. 10 cm apart, into the material to be tested. Both electrodes have to be inserted into the same type of building material. Also, the section to be measured must be coherent and not be crossed by another material. If the material is too hard to press in the electrodes by hand (e.g. cement flooring, concrete, etc.) drill 6 mm holes and fill them with contact paste. Then stick the pins into the contact paste.

When the meter is supplied with the M 6 stick-in electrodes as initial equipment, two pins 23 mm, 40 mm and 60 mm long are included in the delivery. They are suitable for measurements in depths up to 30 mm, 50 mm or 70 mm respectively.

The cap nuts should be tightened by means of a spanner. To ensure good contact, drilled holes should be tightly filled to their full depth with contact paste.

Where hard building materials are involved and no contact paste is used, a considerable measuring error must be expected (the values indicated will be too low).

Brush Electrodes M 25

The two brush electrodes, made of stainless steel, are specially designed for depth measurements on hard and soft building materials without using additionally contact paste. To do so, drill two blind holes approx. 5 - 8 cm apart and with a diameter of 6 mm. To ensure sufficient contact, the blind holes must be drilled to a depth of at least 2 cm. Make sure that both electrodes are inserted in the same, coherent material. When testing cement flooring, the blind holes should be drilled to 75 % of the overall thickness of the cement flooring.

To ensure a long life, turn electrodes always clockwise when inserting or withdrawing them. Be careful when using pliers or similar tools.

Deep Electrode M 21-100/250

These two electrodes, exclusively designed for the measurement of set building materials, allow a measuring depth of up to 100 mm or 250 mm respectively. Insulated sleeves prevent the results from being distorted by a high degree of surface moisture such as dew or rain.

Drill two 10 mm dia. blind holes approx. 8 cm or 10 cm apart (the section to be measured must be coherent and consist of the same material).

It is very important that a sharp drill is used at low speed. Where a lot of heat is generated in the hole, it is necessary to wait at least 10 minutes before introducing the electrodes or contact paste. Insert the tube point 30 mm vertically into the contact paste in order to fill it with paste. Clean the outside of the electrode tube right to the point and insert into blind hole.

Prepare the second hole in the same way. Connect measuring cable to the electrode rod and insert the latter into the electrode tube. Press the contact paste to the end of the hole by exerting pressure with the rod. Connect the measuring cable to the meter, press measuring key and read off result.

Warning

The readings may under some circumstances be distorted if there is too much contact material in the electrode tube or if an electrode tube contaminated with contact paste is repeatedly removed and inserted.

Contact Paste

The contact paste is supplied in quantities of approx. 450 g in a plastic box sealed with a screw cap. It is used to produce a good contact between the electrode point and the building material to be measured or to serve as an extension to the electrode point. The moisture displaced by the drilling process is re-conducted to the material to be measured by the water contained in the highly conductive contact paste.

The surface of the material to be measured must not be smeared with the contact paste as the latter has a high conductivity. When using the M 6 electrodes, it is advisable for an appropriate amount of the paste to be rolled into a thin strand and pressed into the hole with the reverse end of the drill.

It is possible to keep the contact paste mouldable by adding normal tap water. The quantity contained in a box is generally sufficient for approx. 50 measurements.

Flat Electrode M 6-Bi 200/300

These two electrodes are exclusively designed for measurement of insulating material through the edge joint of the cement flooring. Spaced about 5 to 10 cm, they have to be pushed forward through the edge joint along the cement flooring down to the insulating layer. Particular care should be taken to avoid that the shrinking hose of the pins is not damaged because otherwise a moist cement flooring can cause measuring errors. The cap nuts should be tightened by means of a spanner or pliers.

The two flat electrodes can only be used with the M 6 electrode handle.

Stick-in Electrodes M 6 - 150/250

The very thin electrode pins are specially designed for testing building or insulating materials for moisture content, if the pin holes shall be kept as small as possible. The two 2 mm dia. pins, made of ductile high-grade steel, can, for example, be stuck approx. 3 to 5 cm apart through the edge joint to the cement flooring into the insulating layer.

For use of these pins being specially developed for measurements through the cross joint of tiles, a special 3 mm dia. hard-metal drill 160 mm long (*Ref. No. 6078*) is available. It permits drilling a hole through the cement flooring up to the insulating layer. The electrode pins should be spaced, if possible, no more than 10 cm (maximum 15 cm).

The electrode pins can be used with the handles of the M 6 electrodes (*Ref. No. 3700*) and with the M 20 electrode (*Ref. No. 3300*).

Test Standard for Structural Moisture Measuring Section

The optionally available test standard (*Ref. No.6071*) permits the user to check proper function of the structural moisture measuring section of the meter as well as of the connecting cable MK 8 and of the measuring electrodes M 6 and M 20 at any time.

To do so, connect the cable to the meter and insert the two plugs in the bushings of the test adapter. If an electrode is to be included in the check, connect it to the cable and insert the two pins into the bushings.

Set selector switch (4) to position »B« and press measuring key (5) when a reading of 45 digits should be obtained. A tolerance of ± 2 digits is admissible.

Equilibrium Moisture Content

What are generally referred to as equilibrium moisture value relates to an ambient temperature of 20 °C and an ambient air humidity of 65 % R.H. These values are frequently also termed »**air dry**«. They must not however be confused with the values at which the material can be processed or worked.

Before painting or laying a floor, the diffusion capacity of the covering and future ambient conditions in the room must be taken into consideration. When laying PVC flooring in a centrally heated room with an anhydrite sub-floor, the flooring cannot be laid until the floor has dried to approx. 0.6 % m.c.

On the other hand, parquet flooring can be laid on a cement floor in a room with normal stove heating, with a moisture range of 2.5 to 3.0 % m.c.

The long term ambient conditions must also be taken into account when assessing wall surfaces. Lime stuff in an old vaulted cellar may have a moisture content of 2.6 % and still be treated. But a moisture content above only 1 % is considered too high for gypsum plaster in a centrally heated room.

It is of prime importance to consider ambient conditions when determining the moisture content of a building material. All materials are exposed to constantly changing temperatures and air humidities. The effect on the moisture content of the material basically depends on the thermal conductivity, heat capacity, resistance to diffusion of water vapour and the hygroscopic properties of the material.

The »desired« moisture content of a material, therefore, corresponds to its mean equilibrium moisture under the changing ambient conditions to which the material is constantly exposed. Air humidity values for Central Europe lie in the range of approx. 45 to 65 % R.H. in summer and approx. 30 to 45 % in winter. A lot of damage occurs in winter, particularly in centrally heated rooms, as a result of these great swings.

It is not possible to set universally valid values. It always requires the craftsman's and the expert's experience to draw correct conclusions from any readings.

In the case of inorganic building materials, the water content is generally given as a percentage of dry weight. The hygroscopic water content of any material is to a large extent proportional to its density, i.e. for all apparent densities of a building material, the same value is shown when giving the moisture in percentage of dry weight, but at twice the apparent density, a reading in percentage of volume would be twice as great.

Table of Comparison Air Humidity - Structural Moisture

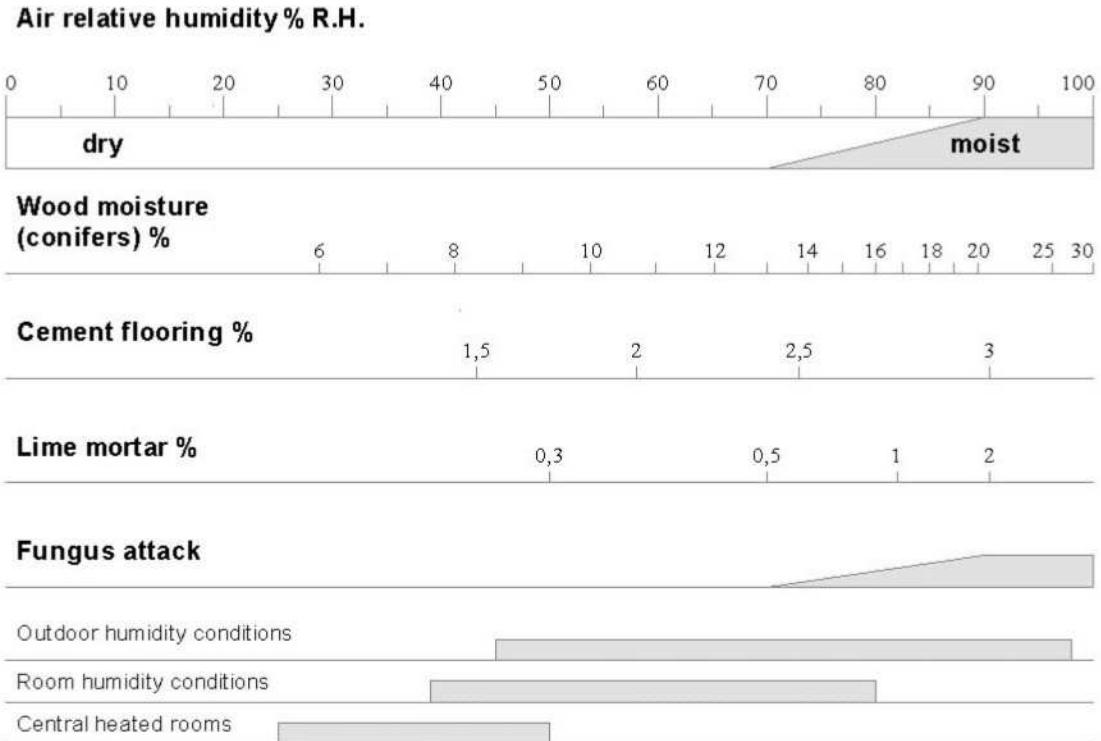

Equilibrium moisture values

The moisture ranges shown in the graphs have the following meaning:

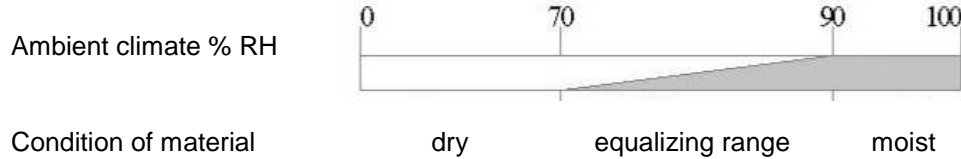

White section:

dry

equilibrium moisture attained

White-black section:

equilibrating phase

Caution: Floor covering or glues impervious to moisture should not yet been processed

Black section:

moist

Performing any work should be avoided

It should be noticed that a state of complete moisture equilibrium is usually achieved only after 1 -2 years. Vapour barriers and long term ambient humidity are decisive factors.

Cement mortar

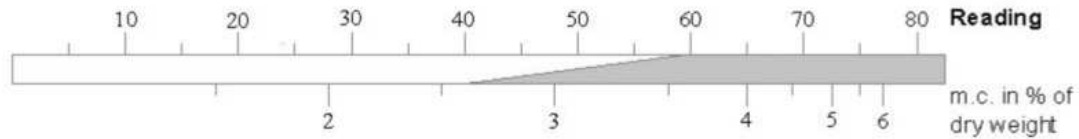

Lime mortar

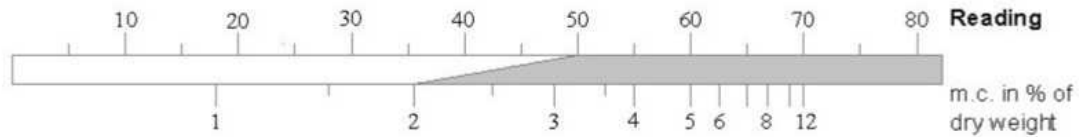

Plaster

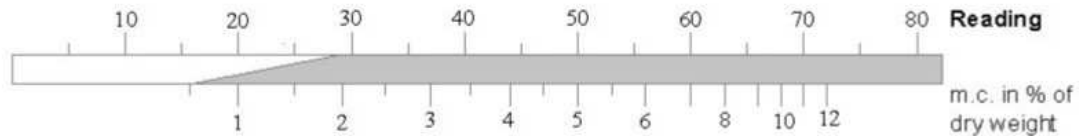

Concrete B 15

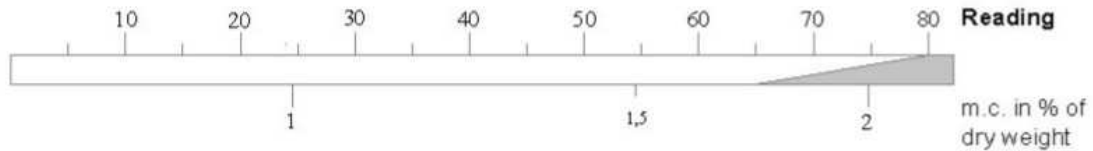

Concrete B 25

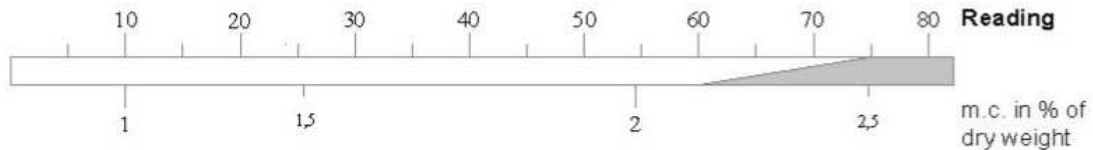

Concrete B 35

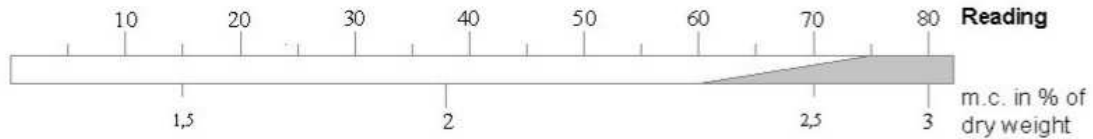

Cement flooring

without additives except
setting accelerator

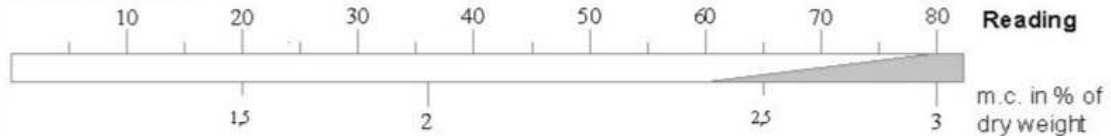

Cement flooring

with addition of synthetics

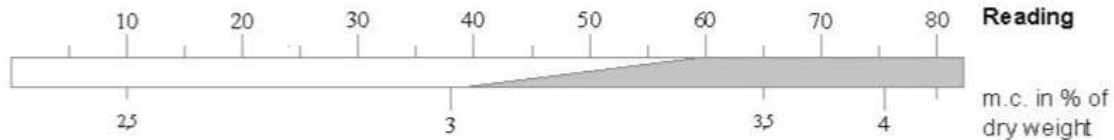

Cement flooring

with addition of bitumen

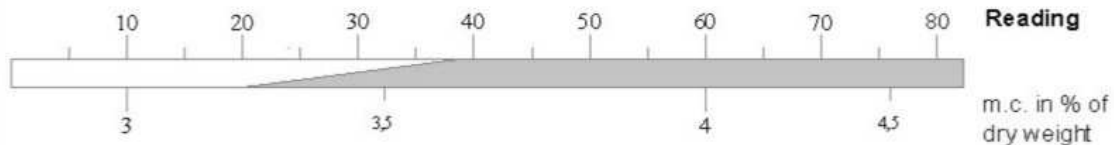

Ardurapid cement flooring

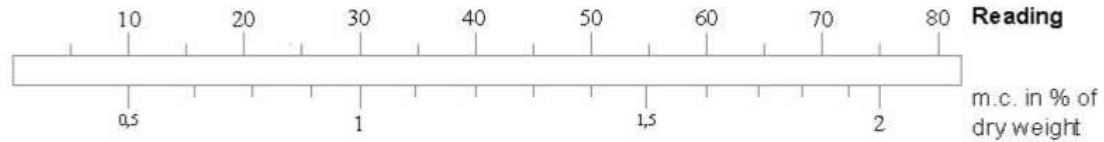

Durament flooring

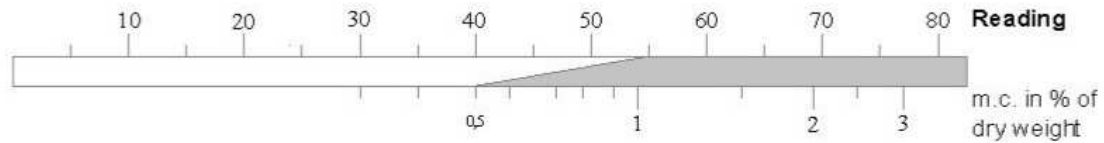

Gypsum flooring

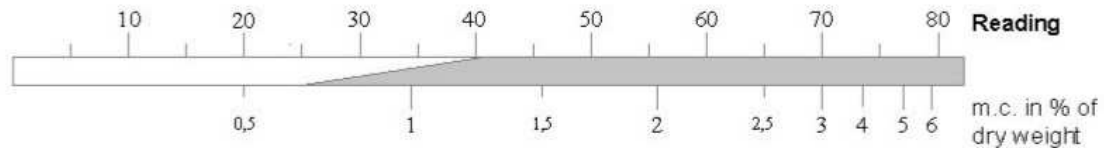

Elastizell flooring

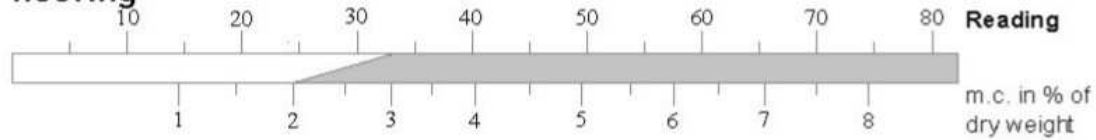

Wood cement flooring

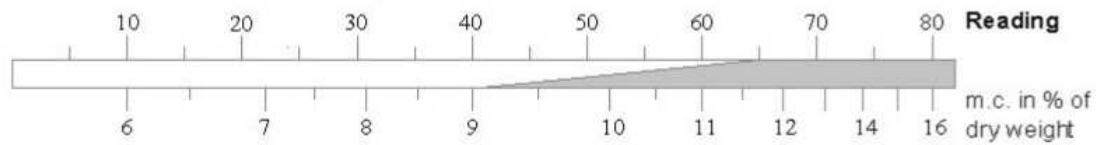

Xylolith

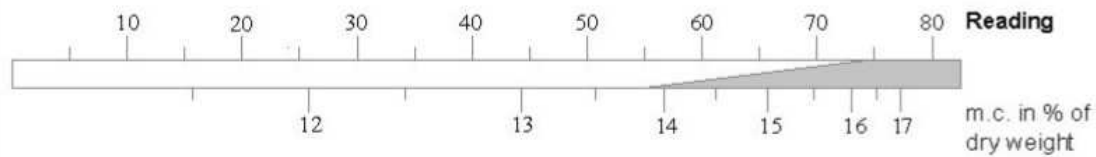

Bitumen based softboard

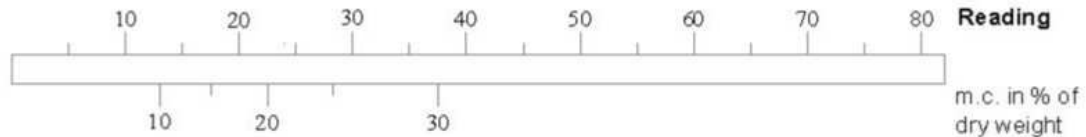

Cork

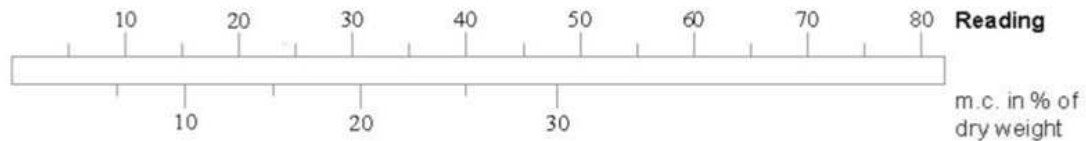

Polystyrene

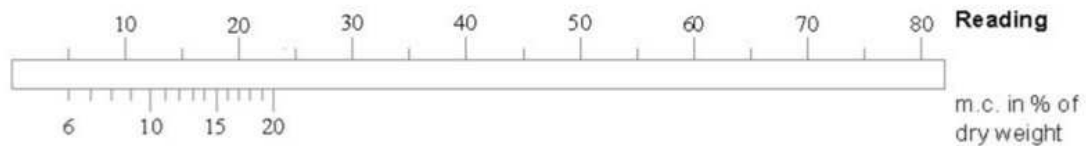

Aerated concrete

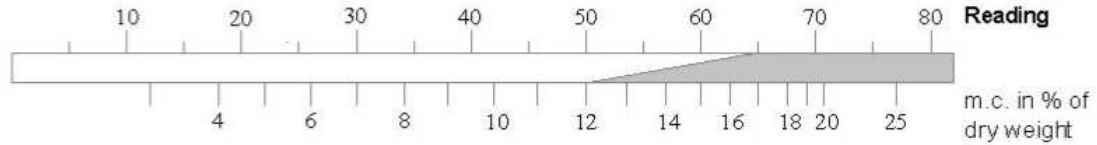

Cement-bonded chipboard

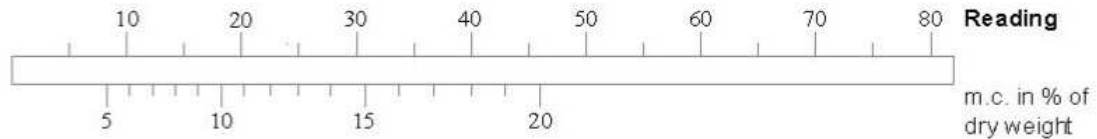

Building or Insulating Materials Not Assignable to One of the Preceding Conversion Graphs

Some building materials, e.g. brick, sand lime brick, etc., cannot be measured with the usual accuracy due to their varying mineral additives or burning times. This does not however mean that comparative measurements on the same material and on the same site would be of no value.

Obtaining various high values may, for example, show the extent of a damp patch due to water damage. Or comparative measures on the dry inside and the damp outside of a wall may show how the drying process is progressing.

Insulating materials, e.g. rock or glass wool, plastic foams, etc., cannot be measured in their dry condition due to their great insulating capacity. Readings fluctuate widely and even give minus values, due to endogenous statics. Damp to wet insulating materials can be measured in the range of 20 - 100 digits or scale divisions. Conversion to percentage by weight or volume percentage is, however, not possible. It is important that the insulating material is not over penetrated by the electrodes. If this is done, an incorrect value may be shown as the underlying support is usually of much higher moisture content.

Final Remarks

The information and tables as well as the general terms and definitions contained in the instructions for use were taken from the specialist literature. The manufacturer or supplier of the measurement equipment therefore cannot be held responsible for the correctness of this information.

The conclusions to be drawn from the measurement results by each user are governed by the individual circumstances and experiences and knowledge gained in the course of his professional practice.

In case of doubt which moisture content, e.g. of the undercoat for a paint or of the sub-flooring for a floor covering is still permissible, the user should ask advice from the manufacturer of the paint or of the floor covering.

- Technical modifications reserved -

Warranty

GANN warrants for six months from date of purchase or one year from date of delivery from his factory whichever period elapses first, to correct by repair or replacement of defective parts free of charge any product defect due to faulty material or poor workmanship. Replacement or repair of any part does not constitute a new warranty period.

When lodging a warranty claim, return the meter complete with all accessories, postage paid, to GANN or to the supplier, together with a description of the fault noticed.

This warranty does not cover batteries, cables and electrode pins. GANN assumes no responsibility for damage or faulty performance caused by misuse or careless handling or storage, or where repairs have been made or attempted by the owner or third party. Proof of purchase is required.

GANN Mess- u. Regeltechnik GmbH

Schillerstrasse 63

70839 Gerlingen, Fed. Rep. of Germany

EC Declaration of Conformity

in accordance with the EC Directive on Electromagnetic Compatibility
89/336/EEC in version 93/31/EEC

We hereby declare that the handheld moisture meter

GANN HYDROMETTE UNI 1 and UNI 2

correspond to the aforementioned directive both with respect to its conception and type of construction and the design as marketed by us.

This declaration becomes void if the moisture meters are modified without our approval.

Applied harmonized standards in particular:

EN 55011/03.91 - DIN VDE 0875-11/07.92
DIN EN 50082-1/03.93

Applied national technical standards and specifications:

IEC 1000-4-2/1995 -IEC 1000-4-4/01.95
IEC 801-3/1984 -IEC 65A/77B

GANN Mess- u. Regeltechnik GmbH, Stuttgart, Germany